

## PROFILE OF ELICO MECHOPTRONIX PVT. LTD.

**ELICO LTD.**, a leading multi division company in lab Analytical Instrumentation for more than 60 Years, renamed its Mechoptronix Division as **Elico Mechoptronix Pvt. Ltd.**, an associate company in the year 2019 to steer ahead with an objective of developing Mechoptronic Products to global standards with the legacy of knowledge acquired from the parent company.

The working team consists of qualified people with versatile experience in design, manufacturing and marketing, committed to bring out products of best in class grade at reasonable price as per the needs of the customers.

**Elico Mechoptronix Pvt Ltd** has in its range Four core Product line and Professional Grade Switches, Optomechanical Products like Optical Mounts, Linear and Rotary Stages and Optical tables of various features, Electro-optic products like Light Sources, Detector Modules, Monochromators, Optics Educational Kits of various features.

Various Electromechanical, Opto mechanical products for the Defence are under development.

The company is in the process of supporting to the Industrial Electronics Sector, Various Educational Institutions, Research Institutions in the field of Optics and Physics, Ordnance Factories, Defense Public Sector Units, DRDO Laboratories, ISRO etc.

With the leverage of the above product range the company is further committed to support by developing high precision, Opto-mechanical, Electro - optical and Eletro-mechanical products for Defence Aerospace applications, Night Vision, Machine Vision and Robotics to global standards.

Elico Mechoptronix Pvt Ltd. has state of art machines like CNC Turn Mill, CNC VMC, CNC Lathe for precision machining, Apart from machinery like Transfer Moulding Presses, Power Presses, Precision Surface Grinder, Precision Milling Machine, Precision Lathe and and is committed to add further machines from time to time to gain strength to give the best to the customers.



**LINEAR STAGES:** These are the rectangular table slide mechanisms to facilitate mounting and linear movements of Optical assemblies in all the three axis (XYZ) discretely and in combination. They have the Micrometer coupled to register accurate movements. They are available in different sizes. The Motorized versions also are offered

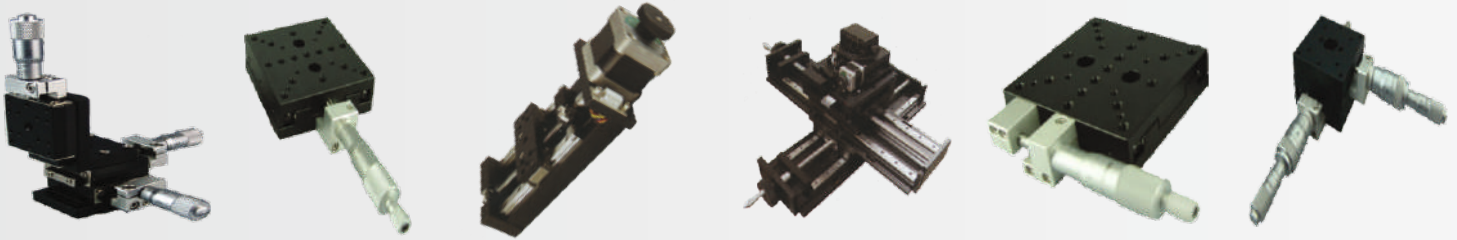

**ROTARY STAGES:** These are rotary table mechanisms to facilitate Horizontal rotary movement of the Optical Assemblies. They have the fine screw mechanism for fine rotary movement.



**ROTARY AND TILT STAGES:** These are precision rectangular and rotary tables for the mounting and adjustment of elements like prisms and beam splitters. Sizes: 46mm dia, 80mmdia. (Rotary) and about 120mm x 80mm (Rectangular). Tilt Resolution: 2 to 3.5 arc secs.

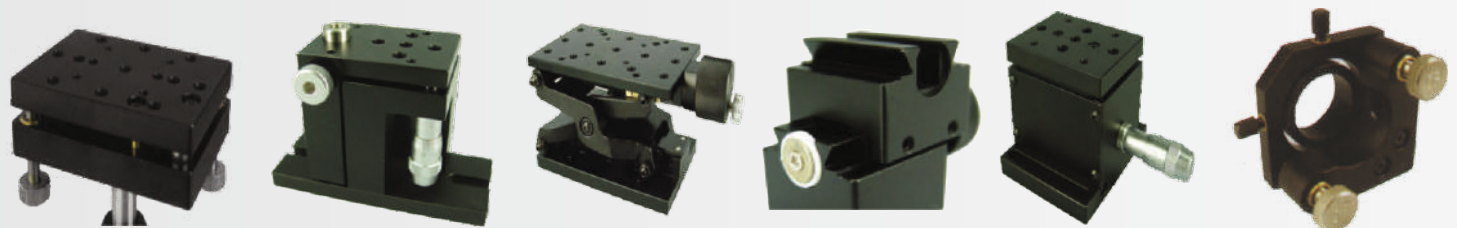

**OPTICAL TABLES:** These are precision rectangular surface plates for the optical assemblies mounted on Non isolating or Isolating frames. They have the Honey Comb matrix to facilitate the clamping of the Optical elements. They are available in custom built sizes also.



STAINLESS POSTS, POST HOLDERS, BASE CLAMPS, LARGE RAILS, ANGLE BRACKETS, FIBER POSITIONERS, FIBER CHUCKS, FIBER COUPLERS, PRECISION LASER MOUNTS, LASER TILTING HOLDERS.



- ◆ KINEMATIC MOUNTS, KINEMATIC MOUNTS WITH ADJUSTERS, FIXED LENS HOLDERS
- ◆ BEAM STEERERS, BEAM SPLITTERS MOUNTS
- ◆ LENSES, PRISMS, FILTERS
- ◆ MIRRORS, BEAM SPLITTERS

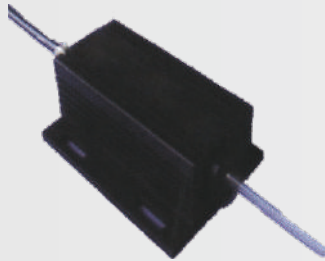

- ◆ TUNGSTEN LIGHT SOURCE
- ◆ DEUTERIUM LIGHT SOURCE
- ◆ MERCURY LIGHT SOURCE
- ◆ FIBER OPTIC LIGHT SOURCE
- ◆ LASERS

All the Light Sources are supplied with suitable Power Supplies

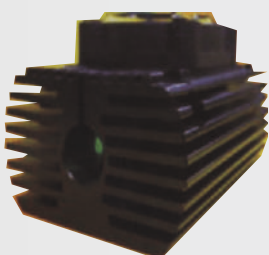
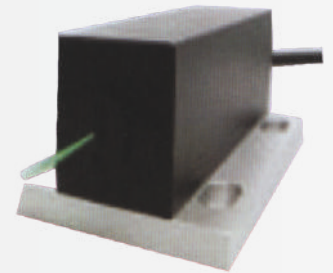

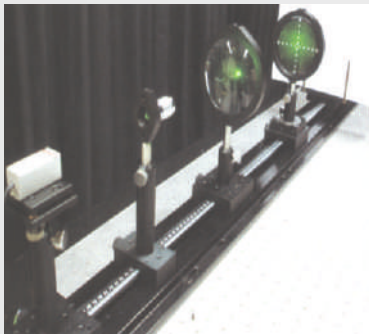
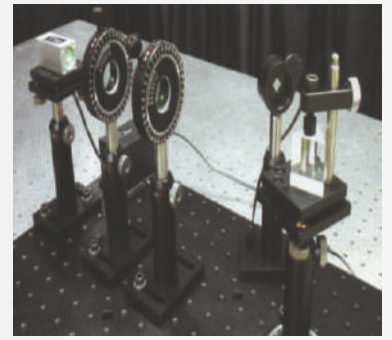
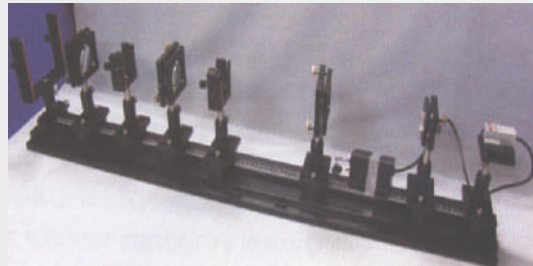
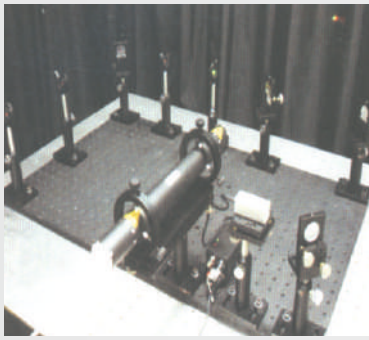

- ◆ BEGINNER'S OPTICS MODULE
- ◆ SNELL'S LAW OF REFLECTION AND REFRACTION
- ◆ POLARIZATION OF LIGHT
- ◆ LENS ABERRATION
- ◆ FOURIER OPTICAL SYSTEM
- ◆ CONCEPT OF OPTICAL-FIBER WAVEGUIDE

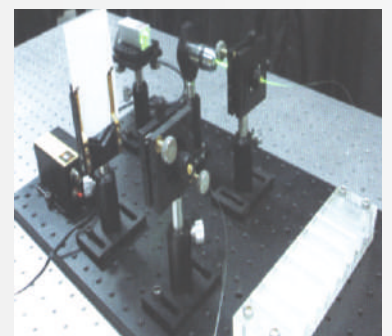
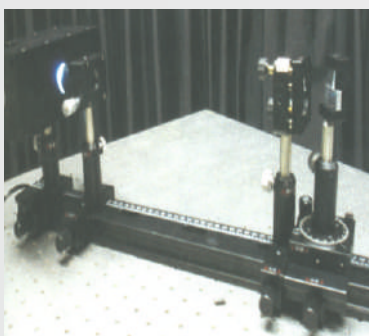
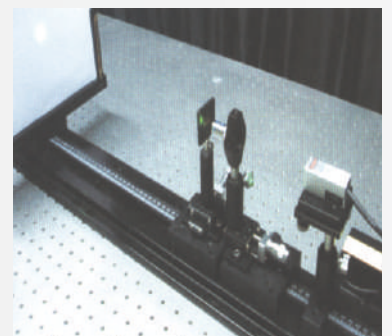
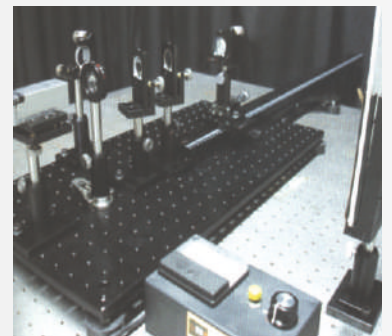
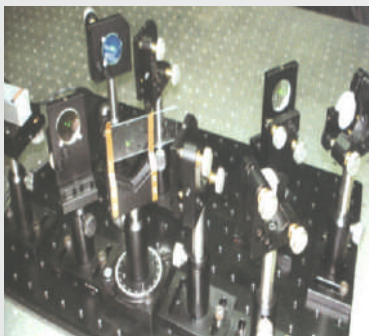

Many more educational kits for experiments in Optics are offered

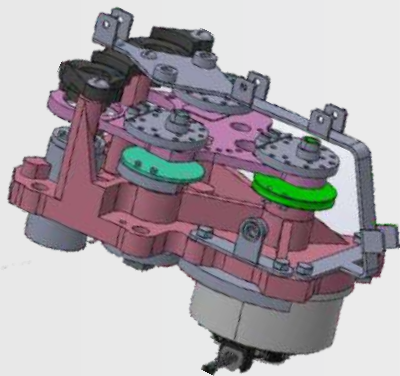
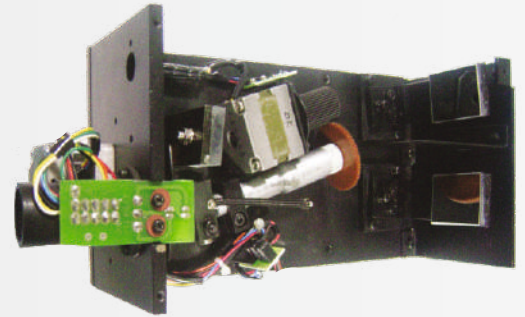
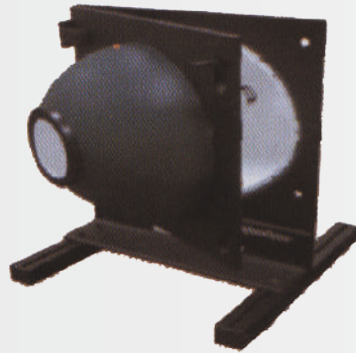
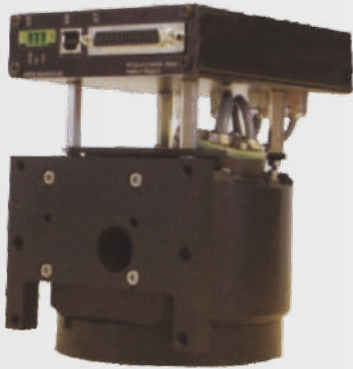

- ◆ MONOCHROMATORS
- ◆ MICROSCOPIC HYPER SPECTRAL IMAGING
- ◆ ACOUSTO-OPTIC MODULATION
- ◆ BEAM PROFILERS
- ◆ CLOSED DEFLECTION SYSTEMS
- ◆ OPTICS MODULE

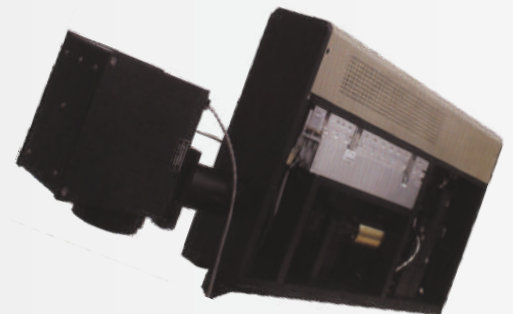
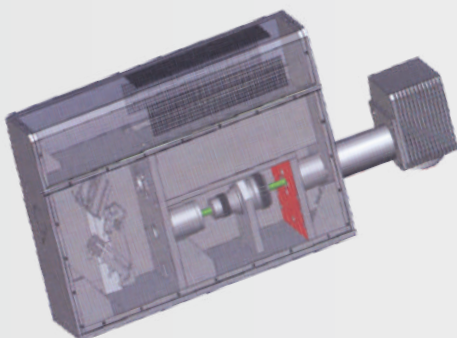
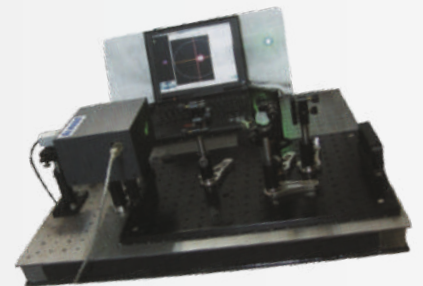
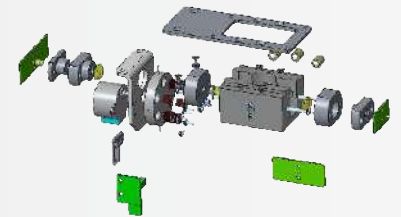
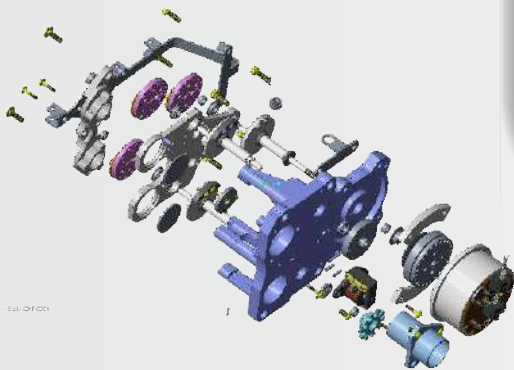
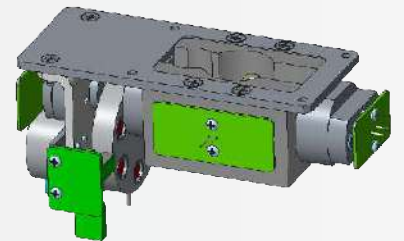



- ◆ HIGH PRECISION CNC VMC WITH 4TH AXIS ROTARY ATTACHMENT - HAAS
- ◆ HIGH PRECISION CNC TURNMILL - HAAS
- ◆ CNC TURNING CENTER - LMW
- ◆ TRANSFER MOLDING
- ◆ SMALL PARTS STAMPING
- ◆ PAINTING
- ◆ LASER MARKING
- ◆ TEST FACILITY FOR MECHOPTRONIC PRODUCTS
- ◆ MITUTOYO CMM & DMG VMC

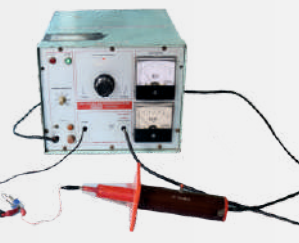
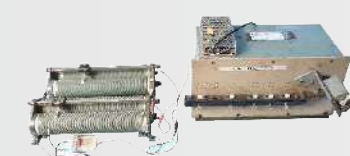

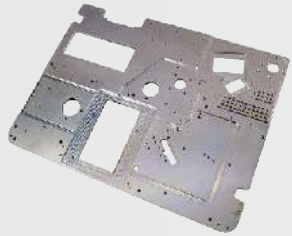

- ◆ PARTS OF MECHOPTRONIX PRODUCTS
- ◆ PRECISION MACHINED PARTS IN VARIOUS MATERIALS



### CUSTOM BUILT PRODUCTS

- ◆ INFRARED CELL HOLDER DRIVE
- ◆ MODULATOR ASSEMBLY
- ◆ GAS UNITS
- ◆ EDUCATIONAL KITS

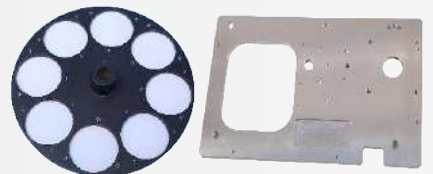

### CUSTOM BUILT PRODUCTS

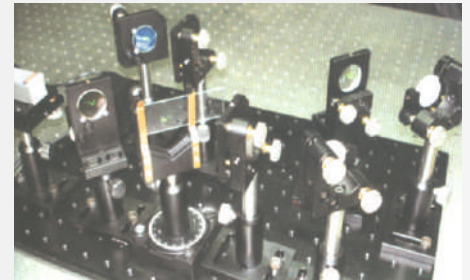

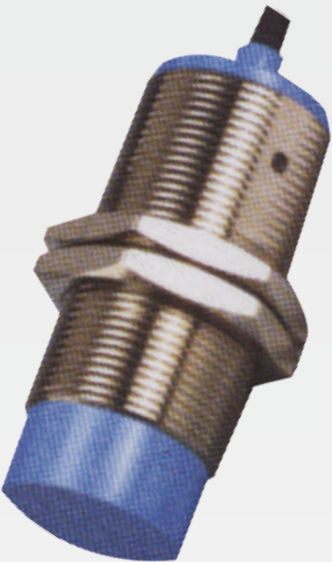
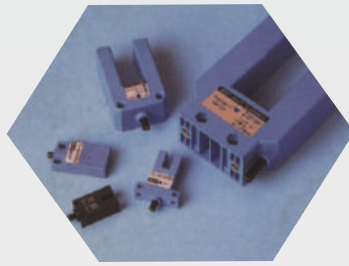
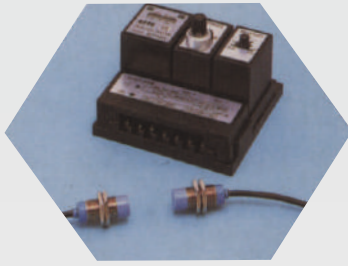

- ◆ INDUCTIVE PROXIMITY SWITCHES
- ◆ CAPACITIVE PROXIMITY SWITCHES
- ◆ PHOTOELECTRIC PROXIMITY SWITCHES







**ELICO MECHOPTRONIX PVT. LTD.**

B-90, A.P.I.E., Sanathnagar, Hyderabad - 500 018.  
Tel: +91 40 44451286, Fax : +91 40 44451284 / 23771639.  
Mob : +91 9866 00 5441, 9100 674 671  
Email: [info@mechoptronix.com](mailto:info@mechoptronix.com) URL: [dev.mechoptronix.com](http://dev.mechoptronix.com)



**V. Venkappa**  
Managing Director

[venkappav@mechoptronix.com](mailto:venkappav@mechoptronix.com)

**ELICO MECHOPTRONIX PVT. LTD.**

Survey No. 62/1/A, Bahadurpally,  
Dundigal Gandimaisamma Mandal,  
Hyderabad - 500 043, T.S., INDIA.  
Reg. Off: B-90, APIE, Sanathnagar,  
Hyderabad - 500 018. T.S., INDIA.

Tell : +91- 90-44451234

Cell : +91- 98660 05441

<http://www.elico.co>



**U. Ravi Kishore Reddy**  
Sr. Manager - Operations

[ravikishoreu@mechoptronix.com](mailto:ravikishoreu@mechoptronix.com)

**ELICO MECHOPTRONIX PVT. LTD.**

Survey No. 62/1/A, Bahadurpally,  
Dundigal Gandimaisamma Mandal,  
Hyderabad - 500 043, T.S., INDIA.

**Reg. Off:** B-90, APIE, Sanathnagar,  
Hyderabad - 500 018. T.S., INDIA.

Tel : +91-40-44451234

Cell : +91-9100674671

Fax : +91-40-23771639

<http://www.elico.co>